

**User Instructions**  
**K-Bot RX2/RX3**  
**Pool Cleaner**

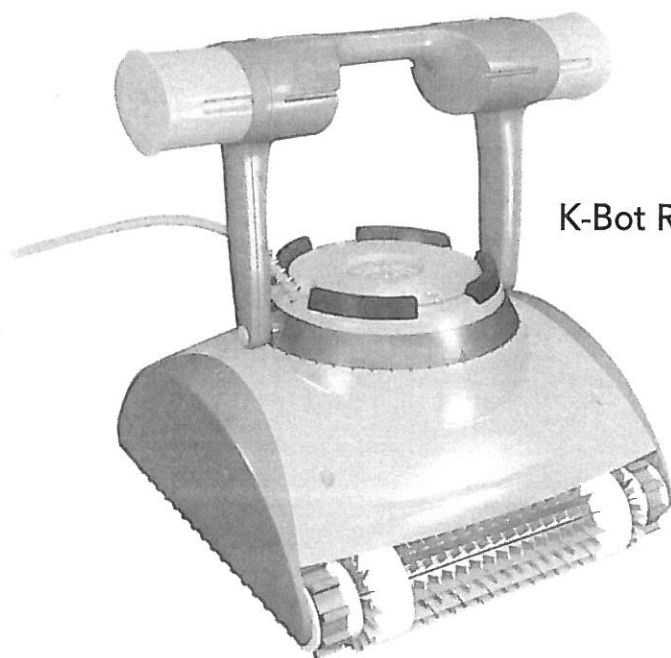

K-Bot RX2



K-Bot RX3

# K-Bot RX2/RX3

## User Instructions

### Contents

1. INTRODUCTION .....	2
2. SPECIFICATIONS .....	2
3. WARNINGS AND CAUTIONS .....	2
3.1. Warnings.....	2
3.2. Cautions.....	2
4. POOL CLEANER PARTS .....	3
5. USING THE POOL CLEANER.....	4
5.1. Setup.....	4
5.2. Putting the Pool Cleaner into the pool.....	6
5.3. Removing the Pool Cleaner from the pool .....	7
6. CLEANING THE FILTER BAG .....	8
6.1. Removing and cleaning the filter bag .....	8
6.2. Replacing the filter bag .....	9
6.3. Cleaning the impeller .....	10
7. OFF SEASON STORAGE.....	11
8. TROUBLESHOOTING.....	12

# K-Bot RX2/RX3

## User Instructions

### 1. INTRODUCTION

Thank you for purchasing a Klever Kleena Robotic Pool Cleaner.

We are sure that your Robotic Pool Cleaner will provide you with reliable, convenient and cost effective pool cleaning. Its reliable filtration in all pool conditions, active brushing, and all-surface climbing brush enhance maximum pool hygiene.

You and your family will be free to enjoy swimming with full confidence that your pool is completely clean.

### 2. SPECIFICATIONS

Motor protection: IP 68

Minimum depth: 0.80m

Maximum depth: 5m

### 3. WARNINGS AND CAUTIONS

#### 3.1. Warnings



- Use the originally supplied power supply only
- Ensure the electrical outlet is protected by a ground fault interrupter (GFI) or an earth leakage interrupter (ELI)
- Keep the power supply out of standing water
- Position the power supply at least 3m away from the edge of the pool
- Do not enter the pool while the Pool Cleaner is working
- Unplug the power supply before servicing

#### 3.2. Cautions

When not in use store the Pool Cleaner in a shaded area, preferable on the Caddy (if supplied).

Use the Pool Cleaner in the following water conditions only:

Chlorine	Max 4 ppm
pH	7.0 - 7.8
Temperature	6-34°C
NaCl	Maximum = 5000 ppm

## 4. POOL CLEANER PARTS

### ► Robotic Pool Cleaner Model K-Bot RX2

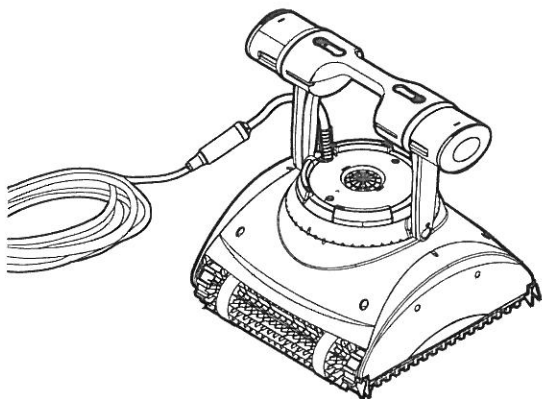

### ► Robotic Pool Cleaner Model K-Bot RX3

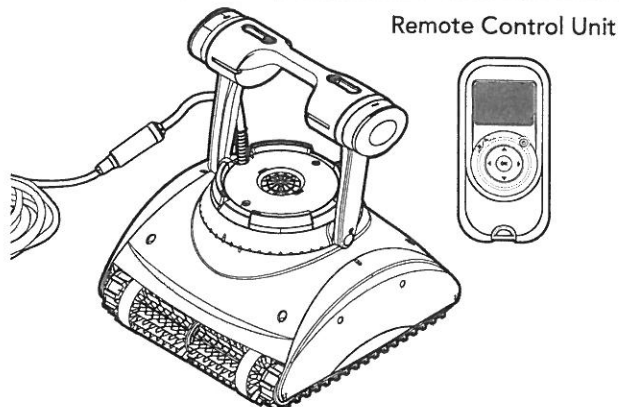

### ► Brushes

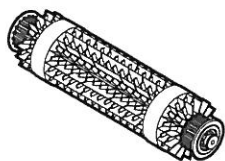

**Combined Brush**  
Matches all pool terrains.

Optional Brushes

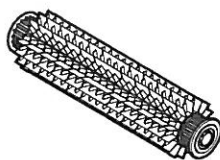

**PVC Brush**  
For concrete, PVC,  
fiberglass and liner.

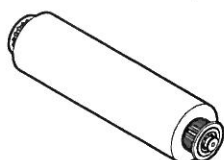

**Wonder Brush**  
For smooth ceramics.

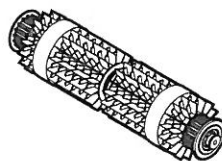

**Combined Brush**  
Matches all pool terrains.

Optional Brushes

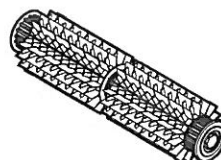

**PVC Brush**  
For concrete, PVC,  
fiberglass and liner.

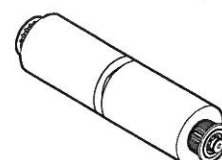

**Wonder Brush**  
For smooth ceramics.

### ► Power supply unit

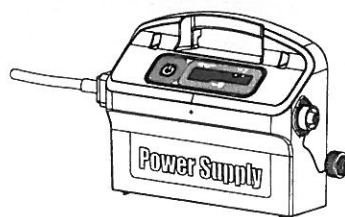
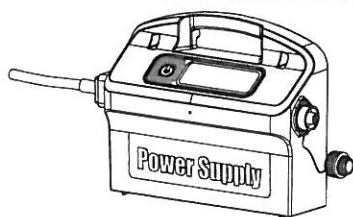

### ► Filtration

Bottom lid and filter Bag

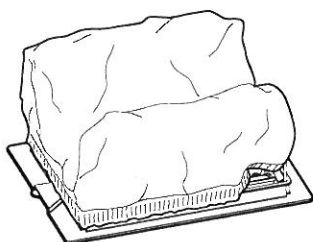

### ► Caddy Kit (if supplied)

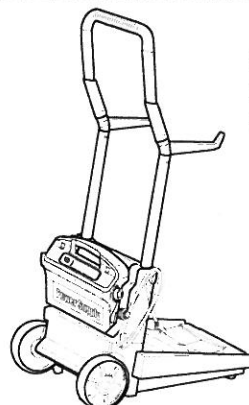

You will find the  
instructions in a  
separate document.

## 5. USING THE POOL CLEANER

The Pool Cleaner is very simple to use. Simply put it into the pool and make sure that it is properly sitting on the floor of the pool. Turn it ON and let it get the job done.

### 5.1. Setup

Before using the Pool Cleaner for the first time perform the following steps:

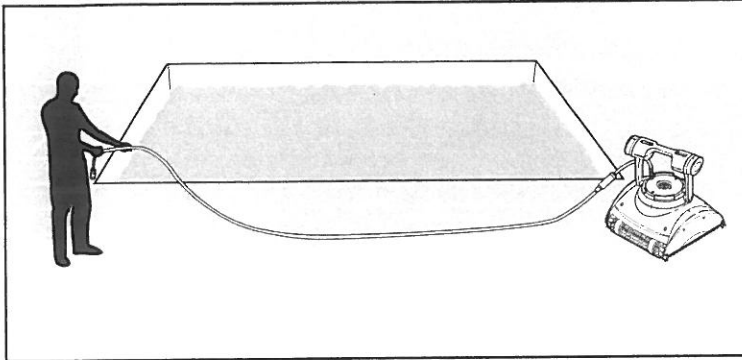

Unwind the cable and stretch it out completely so that it has no kinks.

Some models arrive with plastic coverings on the brushes. Remove them before use.

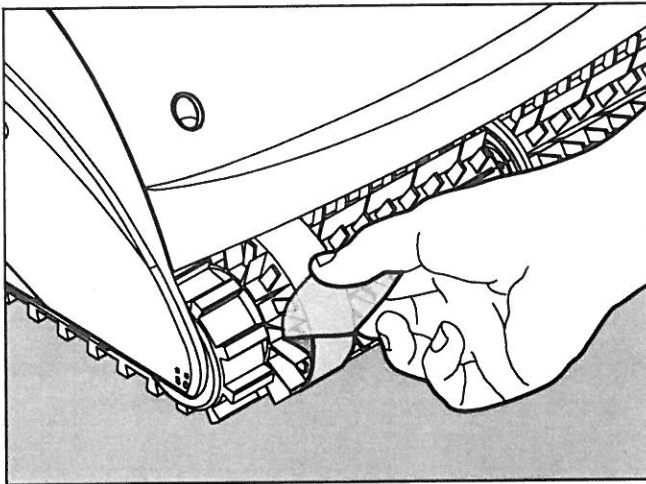

While pushing in the handle buttons turn the ring so that the large projection on the ring lines up with the projection on the Pool Cleaner body.

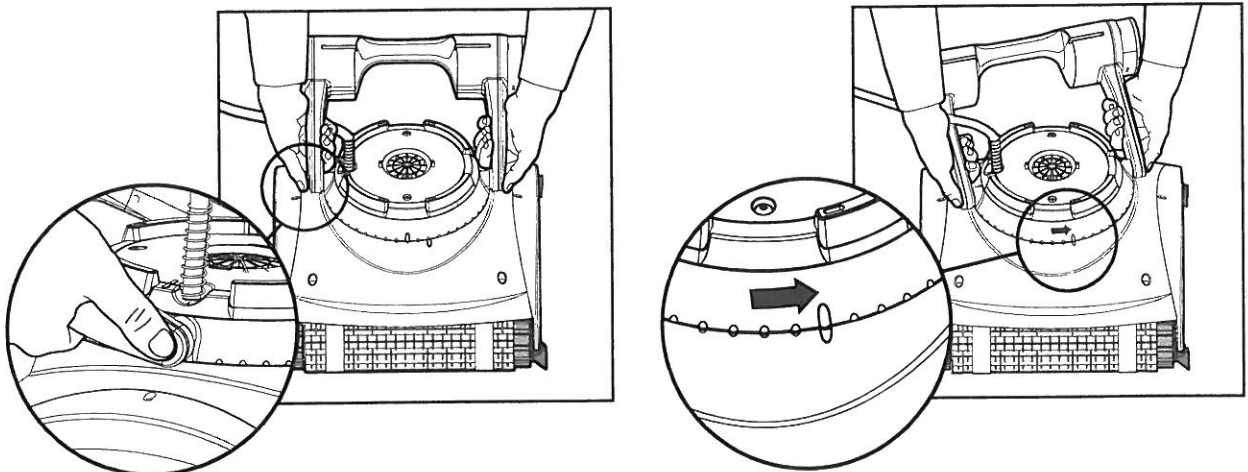

While pushing the button on each float pull it all the way out.

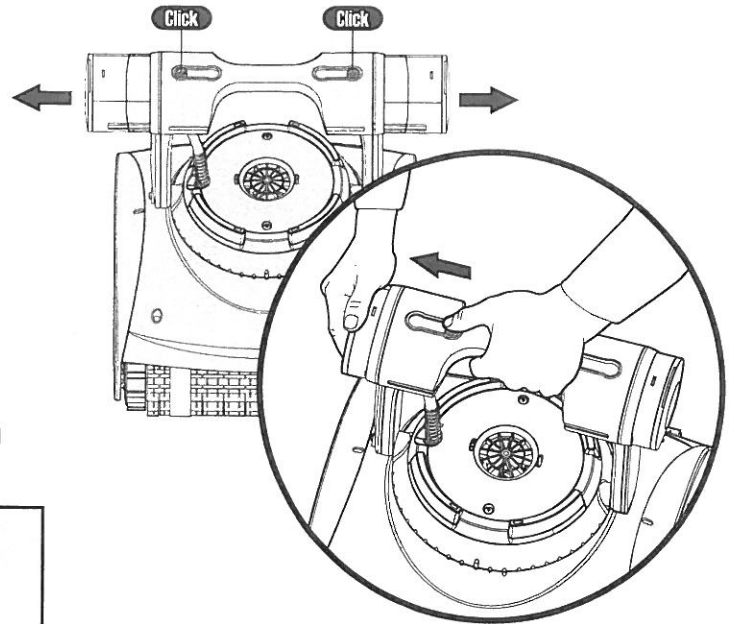

 Position the power supply so that it is approximately in the middle of the long side of the pool at a distance of 3m.

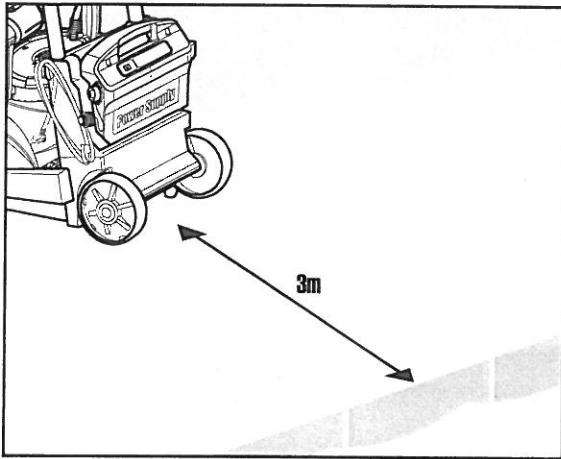

Attach the floating cable to the power supply by inserting it with the notch on the connector (1) lined up with the groove in the socket on the power supply and turning clockwise (2).

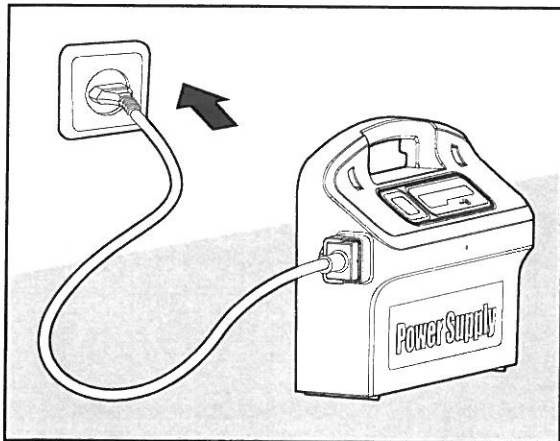
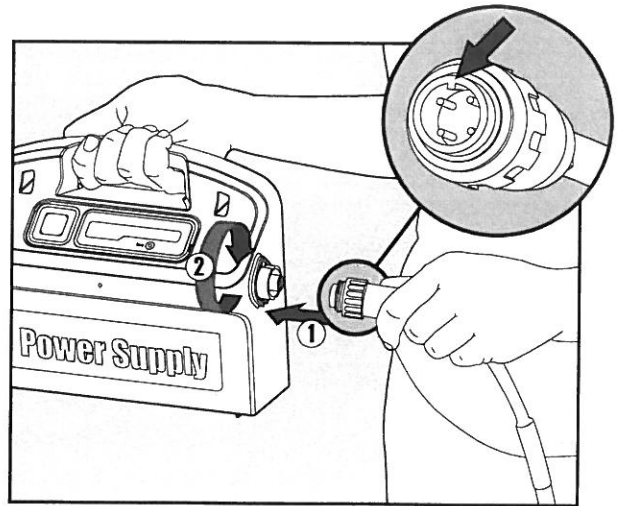

Plug in the power supply and leave it in the OFF position.

## 5.2. Putting the Pool Cleaner into the pool

Holding the Pool Cleaner upside down in the water gently rock it back and forth with your fingers holding the plastic doors on the bottom lid open to release trapped air. Continue until no more bubbles are released.

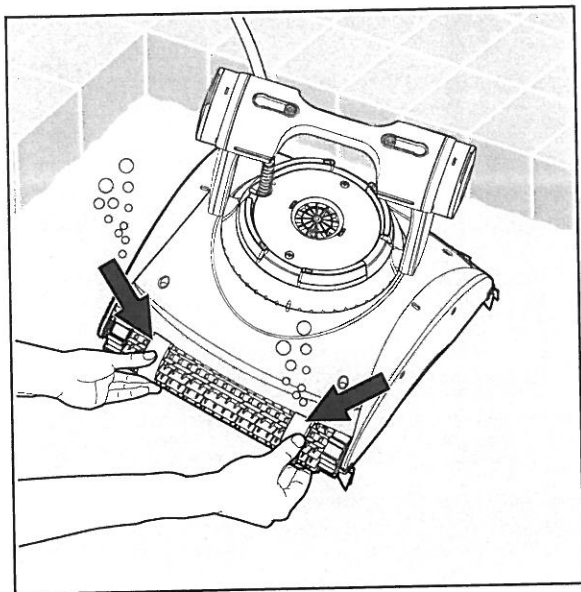
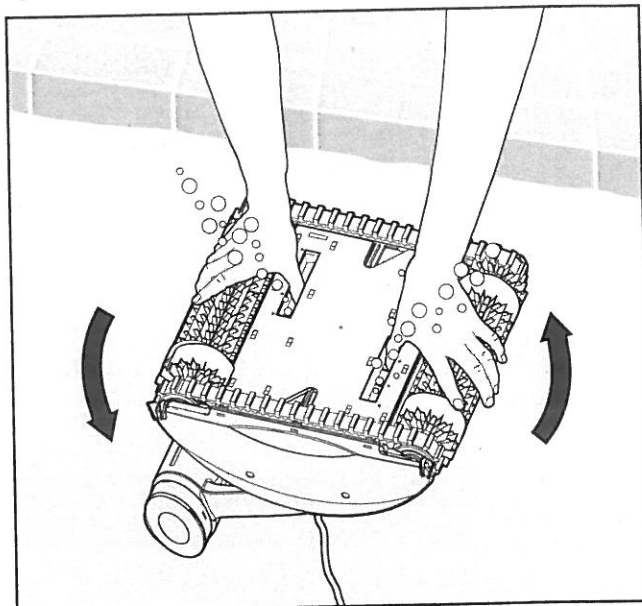

If your Pool Cleaner is equipped with brushes that contain sponges, dip the brushes in the water and squeeze them so that they will absorb water the first time you use the Pool Cleaner, or if the brushes have dried out between uses.

Release the Pool Cleaner and let it sink to the floor of the pool.

Make sure that the floating cable is free of any obstructions.

To avoid kinks in the floating cable, place approximately enough cable in the water for the Pool Cleaner to reach the farthest corner of the pool.

Turn the power supply ON.

The Pool Cleaner will now operate until it has reached the end of the cleaning cycle.

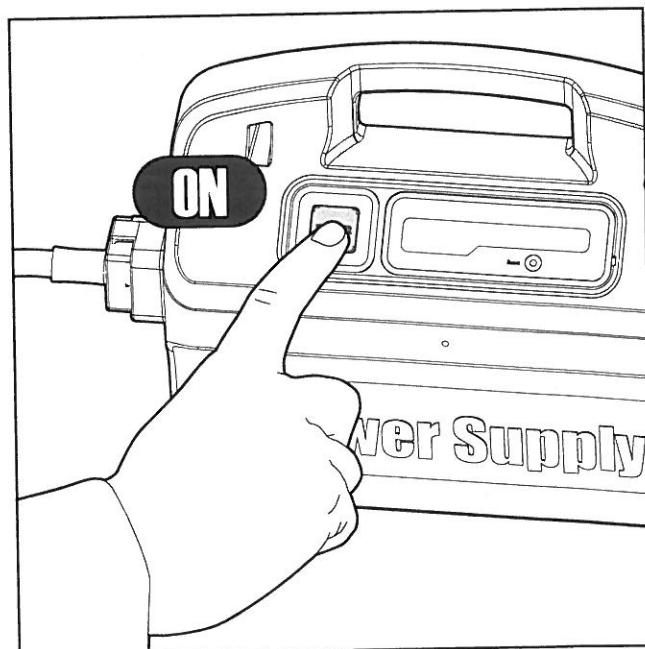

### 5.3. Removing the Pool Cleaner from the pool

 Turn OFF and unplug the power supply

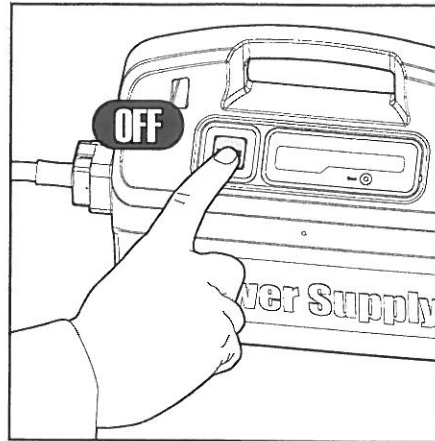

Using the floating cable, bring the Pool Cleaner to the pool's edge.  
Using the handle remove the Pool Cleaner from the pool.

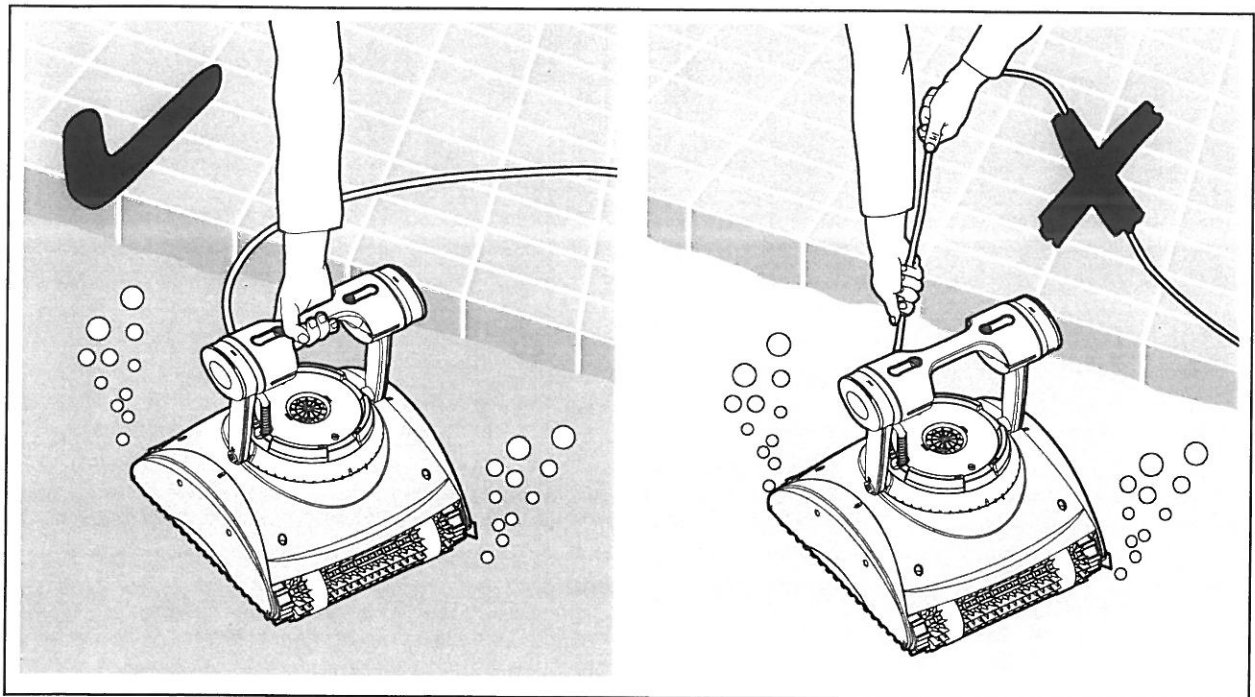

 **DO NOT PULL THE POOL CLEANER FROM THE POOL USING THE CABLE.**

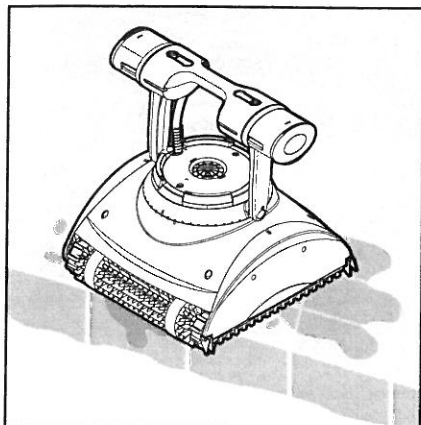

Place the Pool Cleaner on the edge of the pool and let the water drain out.



## 6. CLEANING THE FILTER BAG

It is recommended to clean the filter bag after each cleaning cycle.

### 6.1. Removing and cleaning the filter bag

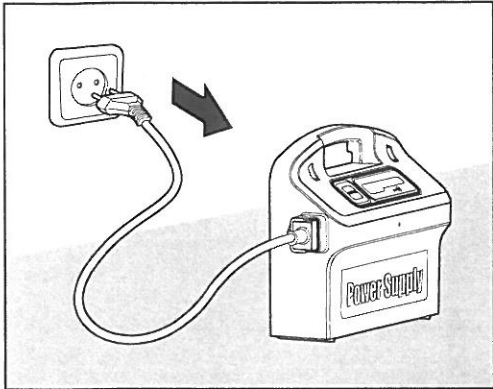

 Unplug the power supply

Turn the Pool Cleaner upside-down.  
Open the bottom lid.

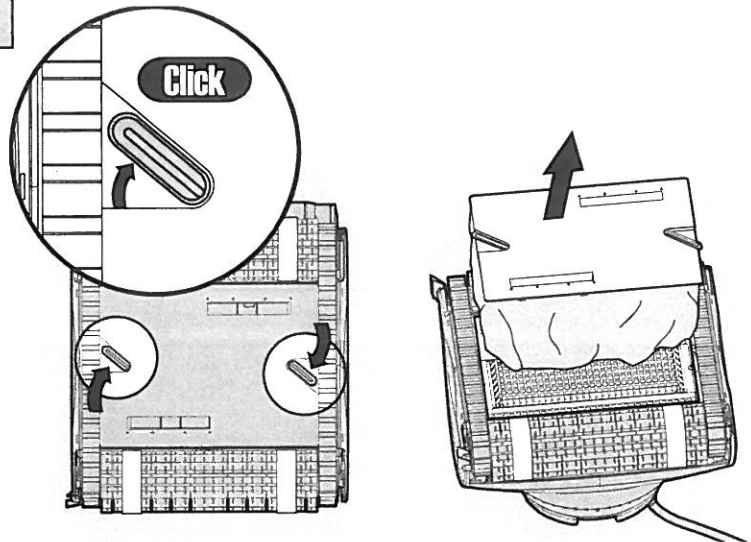

Remove the filter bag.

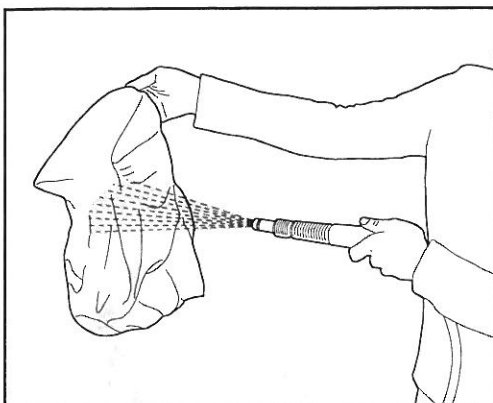
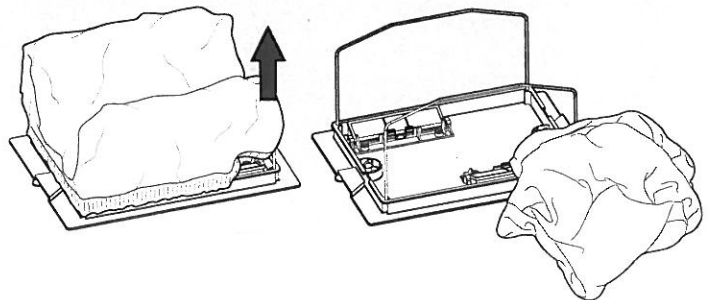

Clean the filter bag with a hose.

We recommend that you periodically wash the filter bag in a washing machine using the gentle cycle program.

Periodically clean the brushes with a hose.

## 6.2. Replacing the filter bag

Put the filter bag over the frame so that the strap is in the middle of the shortest side.

Make sure that filter bag is positioned properly on the frame.

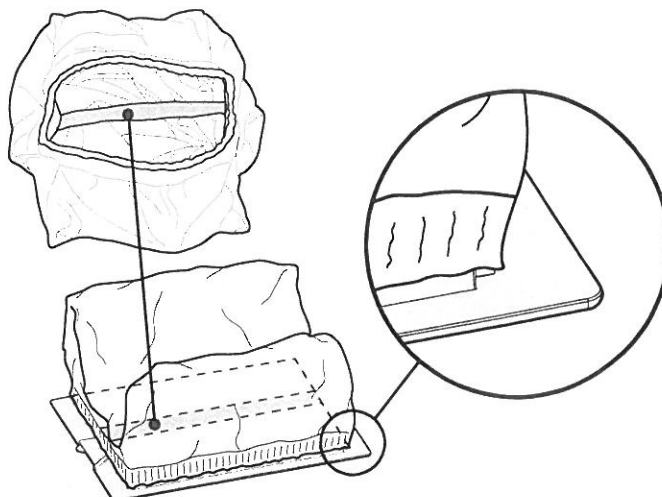
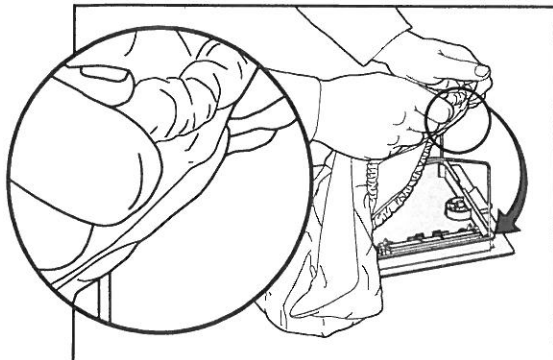

## 6.3. Cleaning the impeller

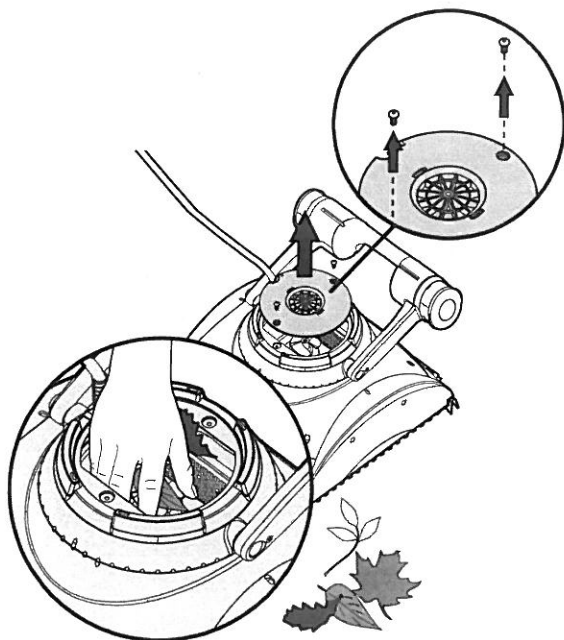

If you notice debris trapped in the impeller open the impeller and remove the debris.

**⚠ Unplug the power supply.**

Using a screwdriver remove the two screws on the impeller cover and remove it.

Clean any debris that may be in the impeller.

Place the impeller cover at an angle so that the notch is on the second ring of the spring.

Press down on the impeller cover in the direction of the spring, pushing it into place.

Replace the screws.

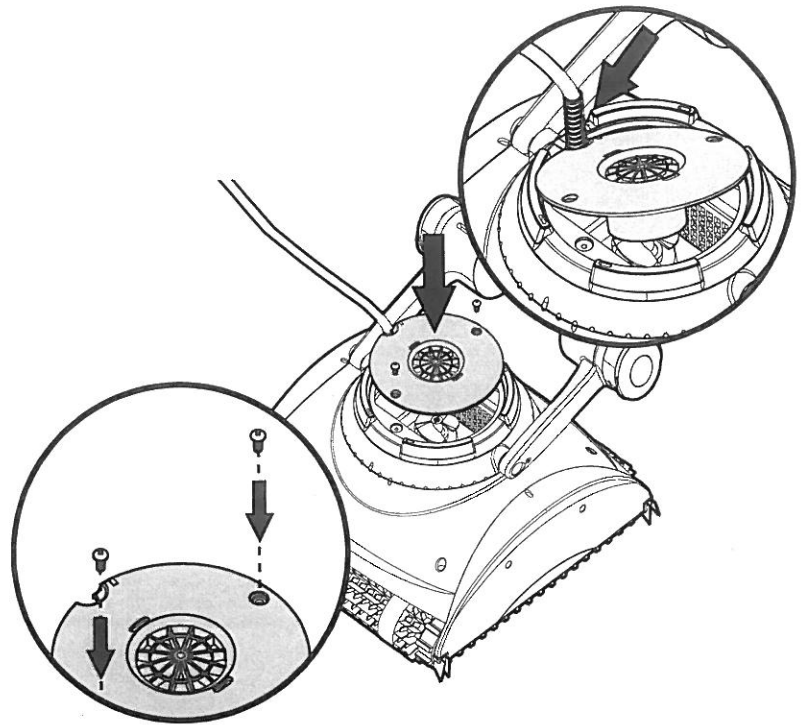

## 7. OFF SEASON STORAGE

If the Pool Cleaner will not be in use for an extended period, perform the following storage steps:

- Make sure that no water is left in the Pool Cleaner.
- Thoroughly clean the filter bag and insert in place.
- Roll up the cable so that it has no kinks (place on the Caddy if supplied).
- Store the Pool Cleaner in a protected area either on its Caddy or simply upside down (not on its brushes).

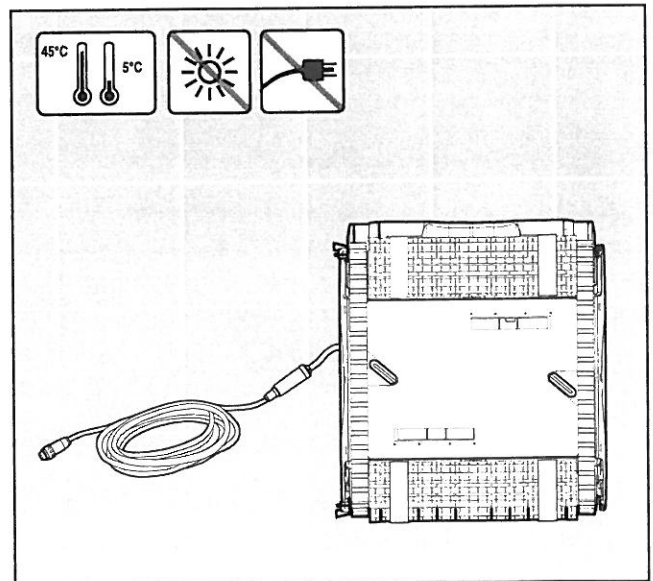
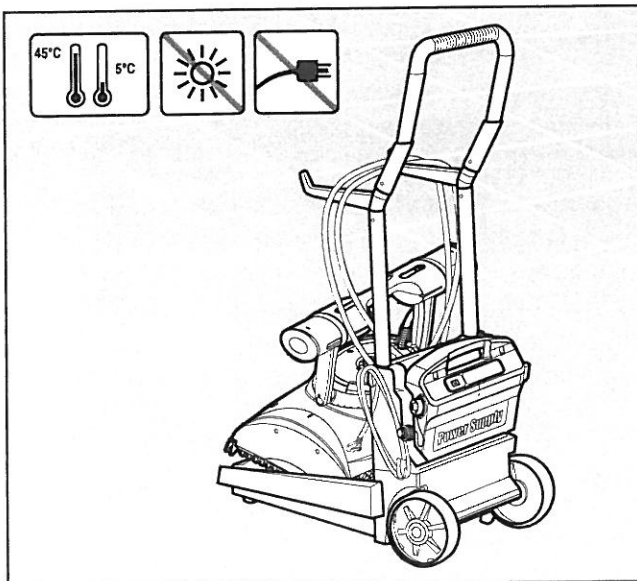

## 8. TROUBLESHOOTING

If the suggested solutions do not solve the problem contact your dealer

Problem	Solution
Pool Cleaner does not move	<ol style="list-style-type: none"> <li>1. Check that the power supply is plugged in and turned ON and that the cable is securely connected all the way into the side of the power supply.</li> <li>2. Ensure the power outlet is functioning properly and that it has not tripped the breaker in the fuse box.</li> <li>3. Turn the power supply off. Wait 30 seconds then turn it back on.</li> <li>4. Unplug the power supply. Open the impeller cover and check that nothing is trapped in the impeller.</li> </ol>
The Pool Cleaner moves but does not clean the pool	<ol style="list-style-type: none"> <li>1. Clean the filter bag.</li> <li>2. After the Pool Cleaner starts moving observe it for several minutes and make sure that it keeps moving. If it stops moving check the impeller and the drive system to see if any debris is stuck there.</li> </ol>
The Pool Cleaner cleans only part of the pool	<ol style="list-style-type: none"> <li>1. Check that there is enough slack in the cable for the Pool Cleaner to reach all of the pool.</li> <li>2. Clean the filter bag.</li> <li>3. For K-Bot RX2 only: push in the float on the cable side (see figure A).</li> <li>4. Check the brushes to see if they are obstructed or worn out.</li> </ol>
The Pool Cleaner floats instead of sitting on the floor of the pool	<ol style="list-style-type: none"> <li>1. Try removing the air again.</li> <li>2. With the Pool Cleaner in the water squeeze the combined brush/Wonder brush to make sure that they are completely water absorbent.</li> </ol>
Cable has kinks	<ol style="list-style-type: none"> <li>1. For K-Bot RX2 only: push in the float on the non-cable side (see figure B).</li> <li>2. To remove the kinks stretch the cable out completely and let it sit for at least a day in the sun.</li> </ol>
The Pool Cleaner doesn't climb the walls	<ol style="list-style-type: none"> <li>1. Clean the filter bag.</li> <li>2. Check the level of the chemicals of the water. Improper levels may allow the growth of algae making the walls slippery. If so, adjust the levels and scrub the walls.</li> <li>3. Check that the brushes aren't worn out.</li> <li>4. Check that the wall climbing mode hasn't been cancelled via the remote control unit (K-Bot RX3 only).</li> </ol>

